

■ iPot®

Scheda Tecnica
Specification Sheet

■ iPot structure

Componenti e materiali

Components and materials

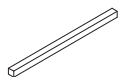

Bacchette

Tubes

MATERIALE / MATERIAL: aluminium_Alloy 6060-profile 7S7314

FINITURA / FINISH: powder coated

COLORE / COLOUR: RAL 9010 (white) / RAL 9005 (black)

DIMENSIONI / DIMENSIONS:

square profile 1 cm / length 19.5 cm

3 directions



4 directions



5 directions



6 directions



Snodi

Joints

MATERIALE / MATERIAL: Grade_Tecomid® NB40 GR30 NL 100

Descrizione / Description: PA6, 30% glass fiber reinforced

COLORE / COLOUR: white / black

DIMENSIONI / DIMENSIONS: (visible part) 1 x 1 cm

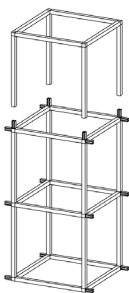
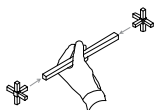

Dimensioni struttura

Structure dimensions



1 MODULE = 21,5 x 21,5 x 21,5 cm

[21,5 cm = 1 cm (joint) + 19,5 cm (tube) + 1 cm (joint)]

+ MODULES = 20,5 cm x N + 1 cm

N = numero dei moduli / modules number

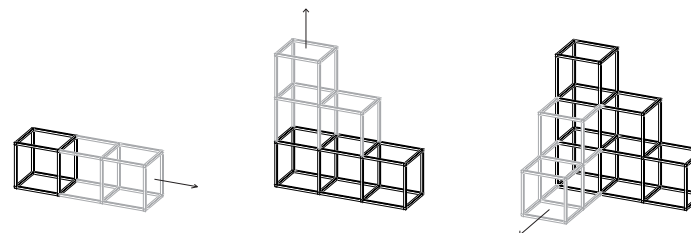

Aperture / openings (grid interruptions)

Sono possibili aperture di diversa forma e dimensione in multipli del modulo base.

Openings of different shapes and dimensions are possible by multiplying the base module.

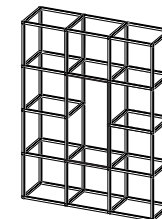

apertura / opening
19,5 x 40 cm

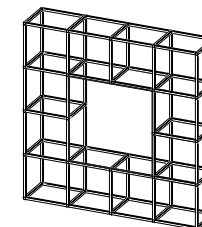

40 x 40 cm

iPot structure

Regole generali di Assemblaggio

General assembly rules

01. Costruire gli elementi base
Built basic elements

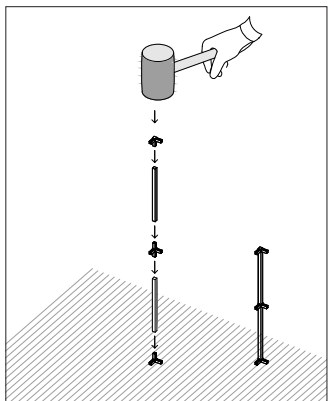

02. Unire gli elementi di base per formare i livelli orizzontali
Join basic elements to create horizontal levels

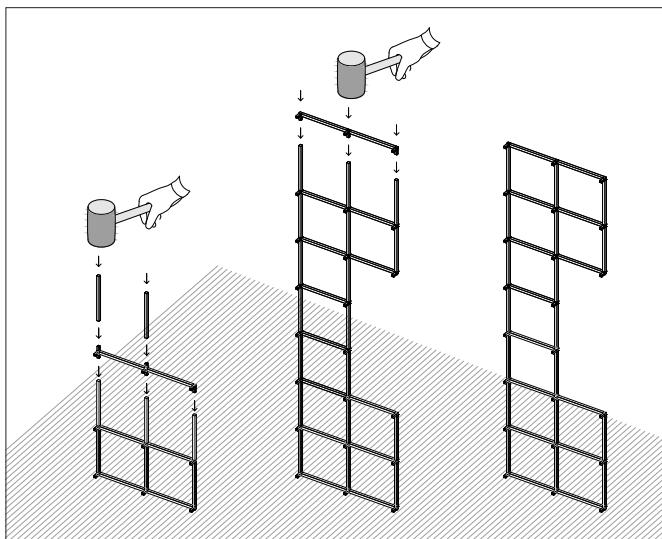
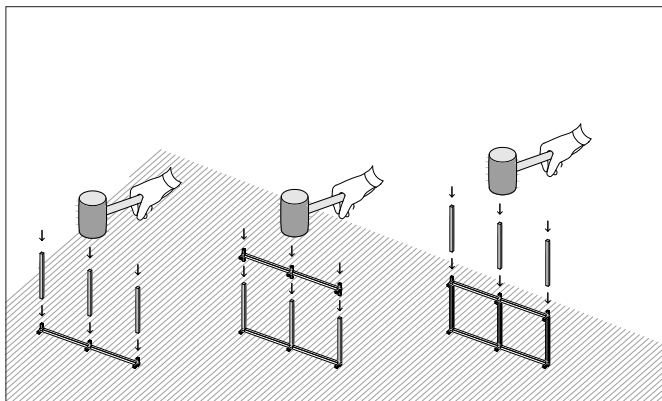

03. Unire i livelli orizzontali
Join the horizontal layers

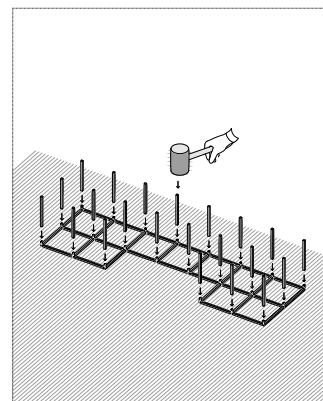

La struttura iPot si assembla incastrando le componenti base: snodi e bacchette. L'assemblaggio è intuitivo e semplice; è necessario utilizzare un martello di gomma. Ogni kit iPot è corredato di istruzioni dettagliate.

The structure is assembled by combining lightweight elements via interlocking aluminum tubes and plastic joints. The assembly is simple and intuitive; you need a rubber mallet. Each kit contains detailed instructions.

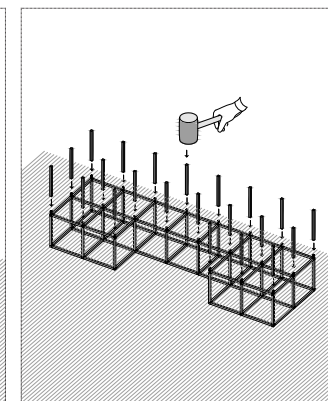
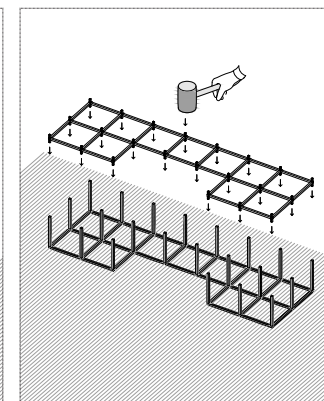

! Aiutarsi con un martello di gomma
We recommend to use
■ a rubber mallet

■ iPot accessories

Sacchetti

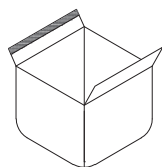

Bags

MATERIALE FODERA INTERNA / INTERNAL LINING MATERIAL:

100% PVC _ 100% waterproof

COLORE / COLOUR: black

MATERIALE FODERA ESTERNA / COVER MATERIAL:

. 100% ac. Dralon® - Teflon®

. 100% cotton

COLORE / COLOUR: various

DIMENSIONI / DIMENSIONS (internal): 18 x 18 x 19 cm

CAPACITÀ / CAPACITY: 5 lt

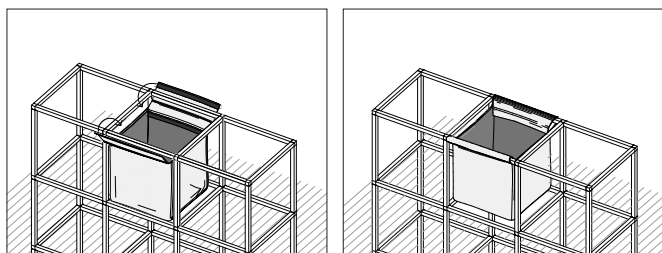

Il sacchetto può essere posizionato liberamente nella struttura grazie alle alette con sistema di chiusura a strappo.

Bags can be freely positioned on your iPot structure by hooking their flaps through their straps system.

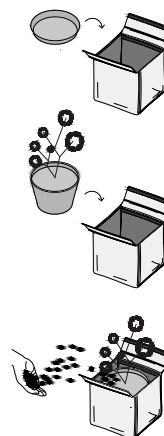

PIANTUMAZIONE / PLANTING

A

Posiziona un sottovaso (Ø18 cm) sul fondo del sacchetto per distribuire il peso

Place saucers (Ø18 cm) at the bottom of the bag to distribute weight.

Inserisci la pianta direttamente con il suo vaso (Ø18 cm)

Insert the plant with its own pot in the iPot bags.

Copri il vaso con uno strato di argilla espansa

Cover the pot with expanded clay



B

Inserisci uno strato di argilla espansa sul fondo per drenare l'eventuale acqua in eccesso

Create a a draining layer on the bottom of the bag by using a water retainer or expanded clay

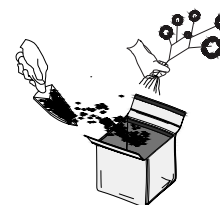

Procedi con la piantumazione della pianta direttamente nel sacchetto. Monitora regolarmente lo stato di umidità della terra

Insert the soil and proceed with planting directly in the iPot bag. Regularly monitoring the compost humidity

■ iPot accessories

Ripiani

Shelves

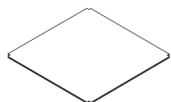

MATERIALE / MATERIAL:

. 100% PMMA

. 100% Birch Plywood

FINITURA . COLORE / FINISH . COLOUR: various

DIMENSIONI / DIMENSIONS: 20,5 x 20,5 cm

spessore / thickness: various

CARICO massimo / maximum LOAD: 5 kg

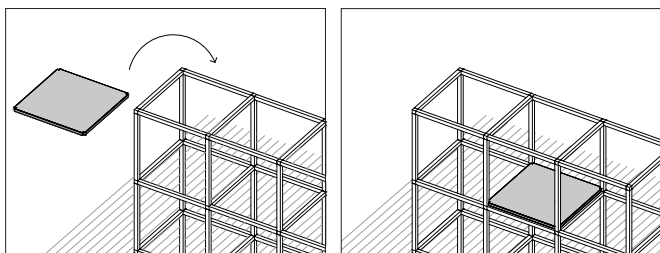

I ripiani iPot si differenziano per tipologia in base al posizionamento nella struttura.

Depending on the position in the iPot structure, the iPot shelves are different.

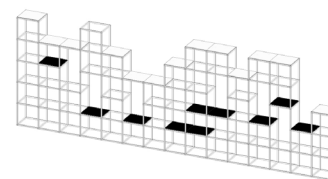

STANDARD

DIMENSIONS: 20,5 x 20,5 cm

thickness: PMMA = 3 mm | Plywood = 8 mm

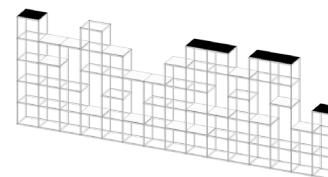

TOP

DIMENSIONS: 20,5 x 20,5 cm

thickness: PMMA = 5 mm | Plywood = 12 mm

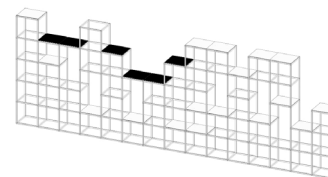

TOP 2C

DIMENSIONS: 20,5 x 20,5 cm

thickness: PMMA = 5 mm | Plywood = 12 mm

■ iPot accessories

Box

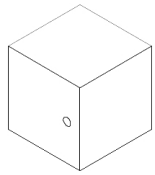

MATERIALE / MATERIALS:

- . 100% PMMA
- . 100% Birch Plywood

DIMENSIONI / DIMENSIONS: various

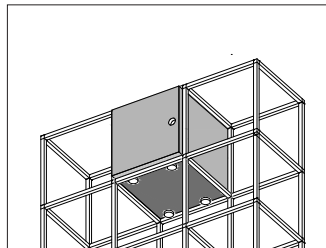
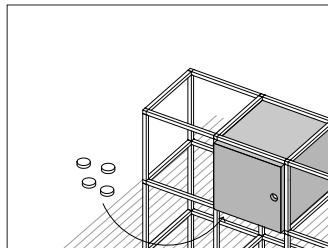
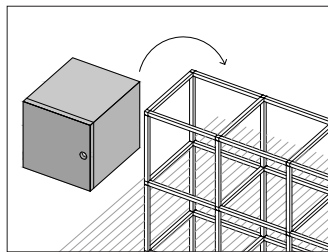

1 MODULE
19,5 x 19,5 x 21,5 cm

2 MODULES
19,5 x 19,5 x 21,5 cm

4 MODULES
19,5 x 19,5 x 21,5 cm

6 FACCE / SIDES

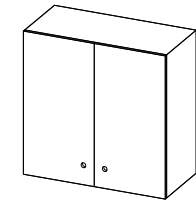
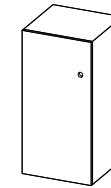
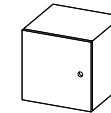

5 FACCE / SIDES

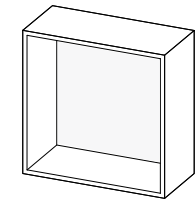
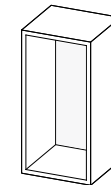
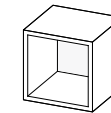

4 FACCE / SIDES

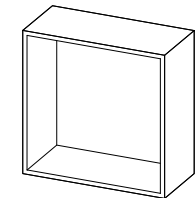
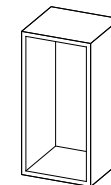
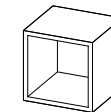

 **supercake srl**
architecture and design

Headquarters
via G. Ventura 5
20134 Milano
ph +39 02 36594656

supercake.it
info@supercake.it

Legal head office
Loc. Sa Gruxi de is Bias (snc)
09039 Villacidro (VS)

PI / CF / VAT N. 03533570929

 **iPot®**

designed and produced by

 **supercake**

made in italy

ipotdesign.it
ipot@supercake.it

